

# EID

## How EID improves farm performance

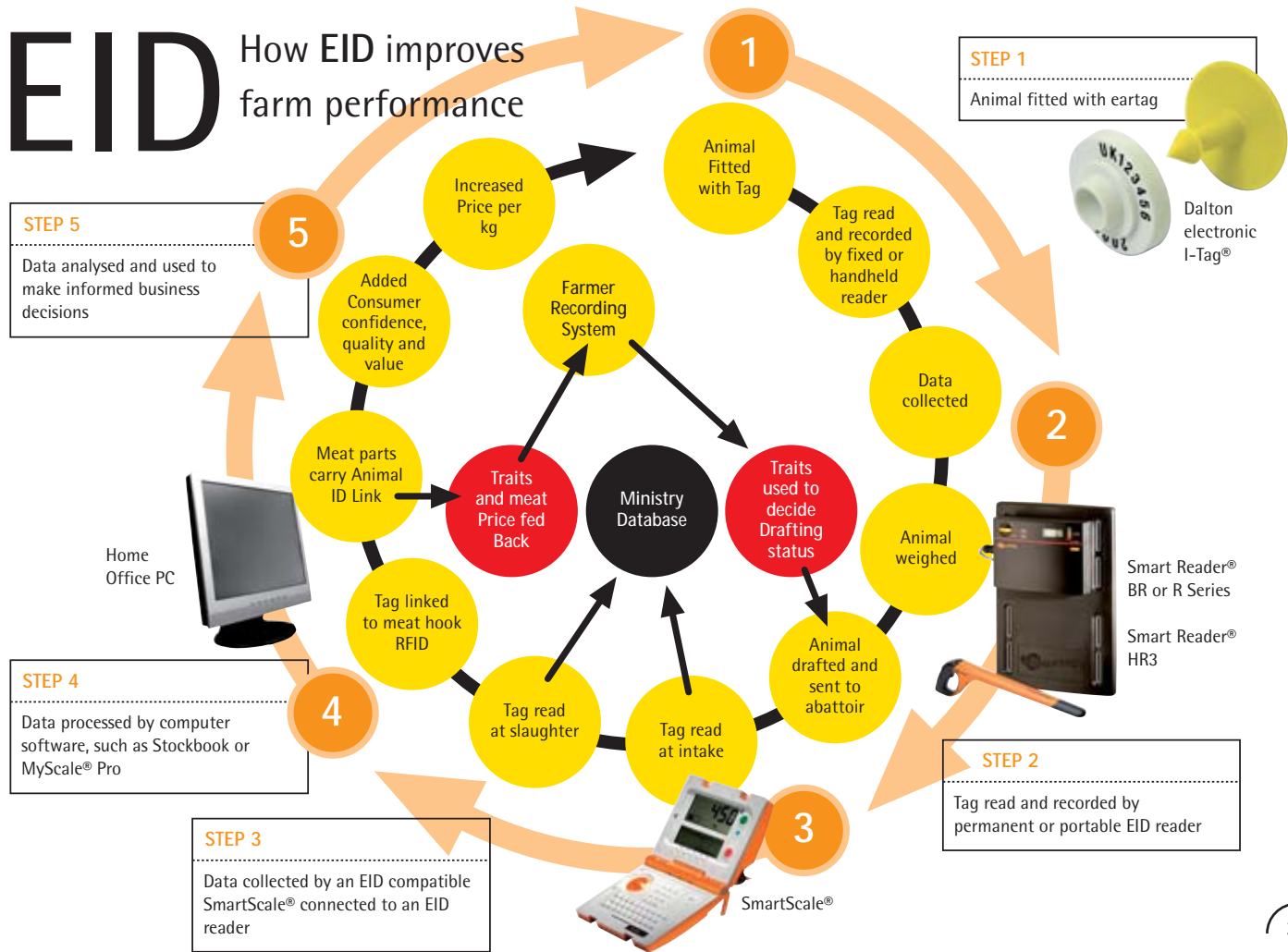

# I-Tag<sup>®</sup> Sheep + Goat

▶ DEFRA Approved

● DARDNI Approved

Male part Suretag<sup>®</sup> ST1 **YE WH GN LB OR RE BK PI**

Female part Electronic I-Tag<sup>®</sup> **YE WH GN**

⌚ 24hr Replacements

*Ordered before 3 pm despatched same day - see „How to order“ Page 52*

📶 HDX or FDX transponder

📦 Free Applicator with first order

*see „How to order“*

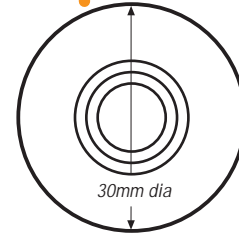

30mm dia

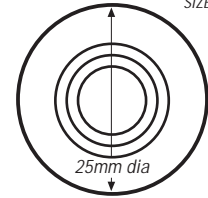

25mm dia



ACTUAL SIZE

\* specify open or closed cap when ordering

Closed cap\* / non re-usable



I-Tag<sup>®</sup> T3  
HDX / FDX



I-Tag<sup>®</sup> T2  
HDX / FDX



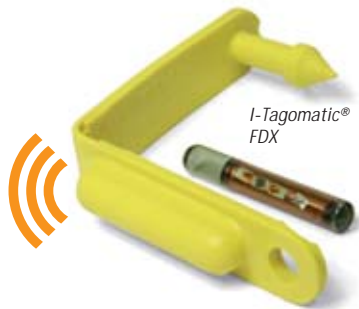

I-Tagomatic®  
FDX



ACTUAL  
SIZE



I-Tag® Loop  
HDX / FDX



Pen I-Tag®  
FDX

ACTUAL SIZES

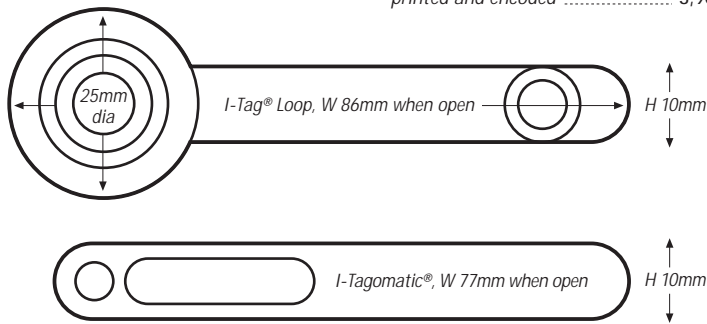
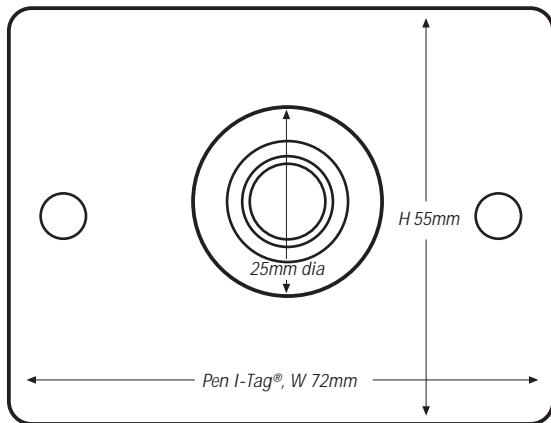

ORDER  
CODE

## PRICING

### I-TAG

S1MFF	I-Tag (FDX) 25mm Button Male & Female, printed & encoded .....	1,60
S1MFH	I-Tag (HDX) 25mm Button Male & Female, printed & encoded .....	2,00
DTIF-U	I-Tag (FDX) 30mm Button Male & Female, printed & encoded .....	1,90
DTIH-U	I-Tag (HDX) 30mm Button Male & Female, printed & encoded .....	2,30
Minimum order quantity 50 tags		
STPIN	Suretag old plier conversion needle .....	3,00
ACSUT	Suretag Applicator .....	18,00
IPOF	I-Tag Loop (FDX) Laser Printed & encoded .....	1,20
ACLOP	U-Tag + I-Tag Loop Applicator (I-Tag Loop + U-Tag) .....	12,00
RCKI	Pen I-Tag Pen Location I-Tag (FDX) printed and encoded .....	3,90

QUESTIONS? FREEPHONE: 0800 838 882

# I-Tag<sup>®</sup> Cattle

- ▶ DEFRA Approved
- DARDNI Approved

I-Tag<sup>®</sup> Colour Range **YE OR WH LB**

⌚ 24hr Replacements\*  
*Ordered before 3 pm despatched same day - see „How to order“ Page 52*

📶 HDX or FDX transponder

£ Free Applicator with first order  
*see „How to order“*



Lifetime Guarantee

Ergonomic handle shaped for hand



I-Tag<sup>®</sup> (ACITG) Applicator

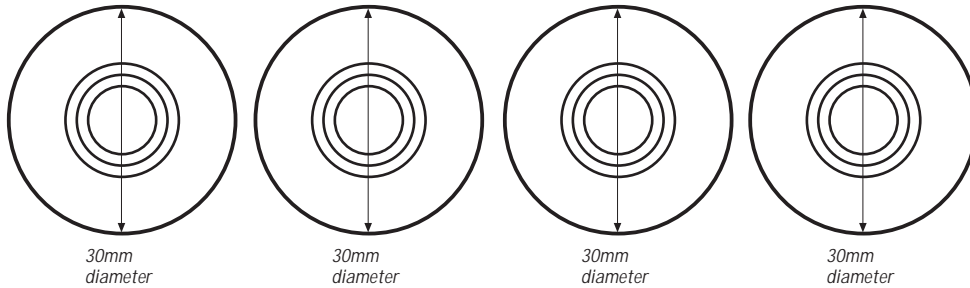

30mm diameter

30mm diameter

30mm diameter

30mm diameter

\* specify open or closed cap when ordering

Open cap\* / re-usable

Closed cap\* / non re-usable

Closed cap\*

Open cap\*



I-Tag® FDX / HDX

I-Tag® FDX / HDX

I-Tag® FDX

I-Tag® FDX



Supertag® male Button  
30mm dia



Startag® male Button  
30mm dia

ORDER  
CODE

## PRICING

### ELECTRONIC EARTAGS CATTLE + DEAR

DTIF-U	I-Tag (FDX) 30mm Button Male & Female, printed & encoded .....	2,00
DTIH-U	I-Tag (HDX) 30mm Button Male & Female, printed & encoded .....	2,40
ACITC	Applicator I-Tag .....	18,00
NSIF-U	I-Tag (FDX) 30mm Button printed & encoded.....	2,00

Minimum order quantity 50 tags

ACSTA	Startag / I-Tag Applicator .....	18,00
STPIN	Old plier conversion needle (Startag).....	3,00



QUESTIONS? FREEPHONE: 0800 838 882

# I-Tag<sup>®</sup> Pigs + Sows

- ▶ DEFRA Approved
- DARDNI Approved

Male part Suretag <sup>®</sup> ST1	YE	WH	GN	LB	OR	RE	BK	PI
Female part Electronic I-Tag <sup>®</sup>	YE	WH	GN					

-  HDX or FDX transponder
- £ Free Applicator with first order  
*see „How to order“*

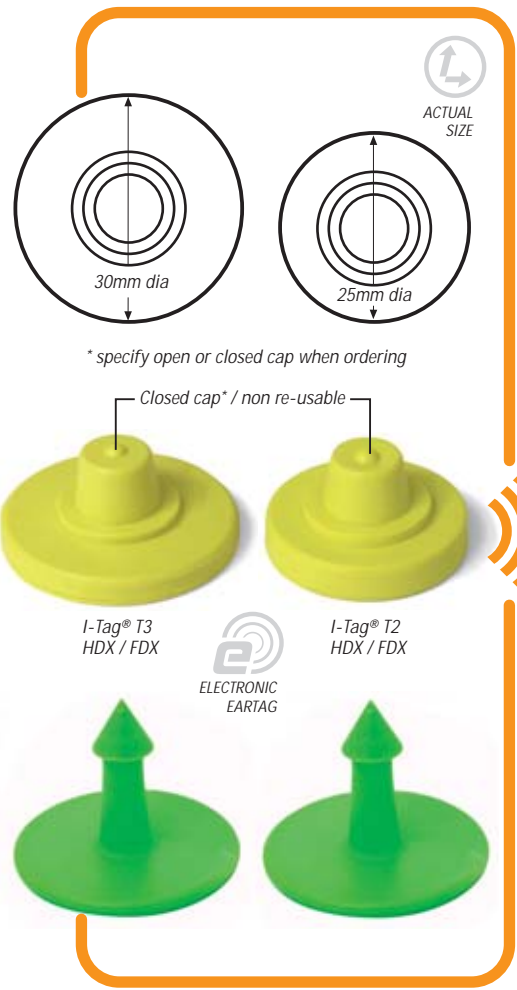



ORDER CODE

## PRICING

### ELECTRONIC EARTAGS PIGS

S1MFF	I-Tag (FDX) 25mm Button Male & Female, printed & encoded .....	1,60
S1MFH	I-Tag (HDX) 25mm Button Male & Female, printed & encoded .....	2,00
DTIF-U	I-Tag (FDX) 30mm Button Male & Female, printed & encoded .....	1,90
DTIH-U	I-Tag (HDX) 30mm Button Male & Female, printed & encoded .....	2,30
STPIN	Suretag old plier conversion needle .....	3,00
ACSUT	Suretag Applicator .....	18,00
IPOF	I-Tag Loop (FDX) Laser Printed & encoded .....	1,20
ACUTG	I-Tag Loop Applicator .....	12,00
DOE	I-Tagomatic Electronic Tag (FDX) printed .....	0,80
DOE2	Double I-Tagomatic Set E tag + Visual Tag combination .....	0,92
ACITA	I-Tagomatic Applicator .....	12,00

Minimum order quantity 50 tags

ACTUAL SIZES

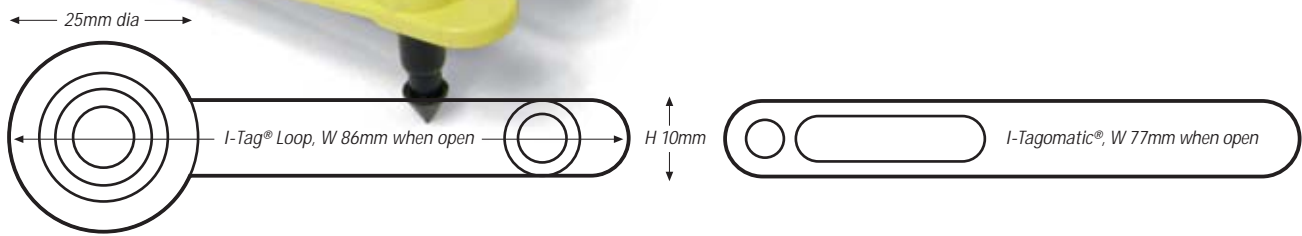

ELECTRONIC for all livestock

# SmartReader®



## Handheld Reader

- ▶ Portable, light and easy to use
- Memory for 5,000 tags
- Use out of the box
- £ Software included



HDX and FDX-B compatible

Graphic LED display



Li-ION Rechargeable



QUESTIONS? FREEPHONE: 0800 838 882



# Technical Data

<i>Case Construction:</i>	Polycarbonate ABS
<i>Frequency:</i>	134.2 KHz
<i>Transponder Types:</i>	HDX compatible (ISO 11784/5) FDX-B compatible (ISO 11784/5)
<i>Memory:</i>	5,000 tags
<i>Reading range:</i>	approx. 25 to 35cm, tag dependant
<i>Communication:</i>	serial RS232 + Bluetooth (class 1-100m)
<i>Power supply:</i>	Li-ION Rechargeable 6+ hours of continuous reads
<i>Power input:</i>	12V DC for charging
<i>Protection level:</i>	IP 66
<i>Display:</i>	„OLED“ 126 x 64 pixels
<i>Temperature range:</i>	-20°C to +85°C
<i>Language:</i>	English
<i>Dimensions:</i>	L x W: 600 x 90mm
<i>Weight:</i>	790g
<i>Included in the box:</i>	Reader, CD Manual, MyScale Pro Mngt. Software, 12v DC intern. Power Supply
<i>Certifications:</i>	CE

## Some features of the Gallagher Portable Reader:

- Lightweight, Robust, ergonomic with hand guard
- Read Alert via Vibration, light on snout and Sound
- Graphic LED display shows;
  - Number of tags read in current session
  - Total Number of tags numbers stored
  - Unique EID number of last tag
  - Battery level charge
  - Reader in record data or transfer mode
- Compatible with SmartScale® and other brands
- Long (600mm) reader snout for easier reading

ORDER  
CODE

## PRICING

GALLAGHER ELECTRONIC HANDHELD READER	
GRGRH	Gallagher® RS232 Handheld Reader HR1, ISO HDX/FDX..... 760,00
GRGBH	Gallagher® Bluetooth Handheld Reader HR3, internal battery ISO HDX/FDX..... 860,00
GRGTH	Gallagher® Bluetooth Handheld Reader HR4, internal battery ISO HDX/FDX..... POA
GRGSO	Interface Software for Gallagher® handheld reader Included

Download full datasheets  
at [www.daltonid.com](http://www.daltonid.com)

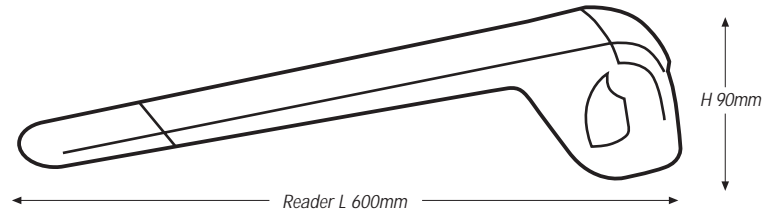

# BioControl

## HHR 3000 PRO V2

- ▶ Lightweight, Robust, Ergonomic
- Memory for 1,000 tags
- Use out of the box
- £ Uploadable application software



*„Condom“ covers charging and USB socket makes it watertight and absorbs shocks*

*Good readable display with clear lights*



*Air coil antenna*

*45 cm antenna extension*

*Rugged handgrip*

*Long antenna*

*Short antenna*

*40 x 60 cm panel antenna*

**BioControl**  
Technology for biology

# Technical Data

## RFID

134.2 kHz

Reads HDX and FDX-B transponder according to ISO 11784/11785

Synchronises to stationary readers according to ISO 11785 clause 6

Advance Digital Decoding technology (ADD)

## Read range

50 cm with HDX ear tag

30 cm with FDX-B ear tag

Limited dynamic reading with Panel Antenna.

Use for reading constrained animal only (e.g. weighing)

## Housing (with fixed long antenna)

*Dimensions:* 825 x 120 x 46 mm

*Weight:* 775 gr.

*Battery:* 2000 mAh capacity, sufficient for 1 day reading

*Dust and water:* IP65

## On-board computer

Non-volatile, 512 Kbytes for animal database and application program

Real-time clock for logging time/date stamp

Upload application program

## Interface

Standard USB 2.0

Optional Bluetooth 1.2, RS232 and GPRS

Supplied with basic PC program to exchange data between PC and HHR 3000 Pro V2 (WIN98, 2000, XP, Vista)

## Approvals and certifications

FCC *complies with Part 15 of the FCC rules*

EU-JRC *certificate 161/07*

CE *meets EN50082-1 and EN50022*

ORDER  
CODE

## PRICING

### BIOCONTROL

#### ELECTRONIC HANDHELD READERS

BC012	BioControl® HHR3000 Pro Bluetooth, RS232 with short antenna fitted.....	870,00
BC019	BioControl® HHR3000 Pro Bluetooth, RS232 with short loop antenna fitted.....	880,00
BC011	BioControl® HHR3000 Pro Bluetooth, RS232 with long antenna fitted.....	890,00
BC020	BioControl® HHR3000 Pro Bluetooth, RS232 with medium antenna fitted.....	880,00
BC007	BioControl® HHR3000 pro V2 long antenna only (60cm).....	100,00
BC010	BioControl® HHR3000 Pro V2 extra long antenna only (115cm).....	150,00
BC016	BioControl® GPRS Option for all readers (SIM card not included), Add .....	150,00
BCAPP	Interface Software for BioControl® HHR reader.....	Included

## FEATURES

The HHR 3000 Pro V2 is an easy to operate Handheld Reader for ISO 11784/11785 transponders. It is designed for on-farm use under "real life" conditions and combines great reading performance, enhanced computer features with ease of operation.

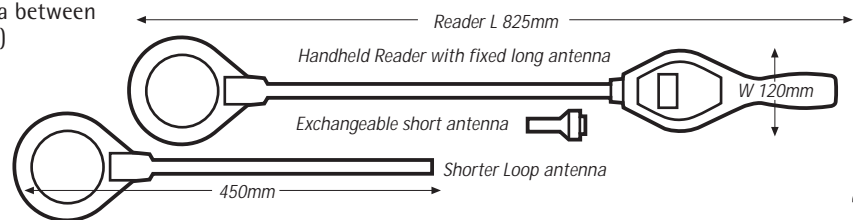

# LiveTrack®

- ▶ Lightweight, Robust, Ergonomic
- Memory for 10,000 tags
- Use out of the box
- £ LiveTrack software included

*Easy to use out of the box:  
the Syscan Reader is an ideal  
solution for feedlots, transporters,  
auction houses and more*



650mm reader snout  
for easier reading



## Handheld Reader



Read Alert via  
Vibration and Sound

7.4v Li-ION  
Rechargeable

HDX and FDX-B  
compatible



*Included in the box: Quick start guide, Reader,  
Livetrack manager software, CD Manual,  
Hand strap, Serial cable & 12v DC international  
Power Supply*

# Technical Data

<i>Case Construction:</i>	Polycarbonate ABS
<i>Frequency:</i>	134.2 KHz
<i>Transponder Types:</i>	HDX compatible (ISO 11784/5) FDX-B compatible (ISO 11784/5)
<i>Memory:</i>	10,000 tags
<i>Reading range:</i>	approx. 25 to 35cm, tag dependant
<i>Communication:</i>	serial RS232 + Bluetooth (class 1-100m)
<i>Power supply:</i>	7.4v Li-ION Rechargeable 6+ hours of continuous reads 12V DC for charging
<i>Power input:</i>	12V DC for charging
<i>Protection level:</i>	IP 66
<i>Display:</i>	„OLED“ 126 x 64 pixels
<i>Temperature range:</i>	-20°C to +85°C
<i>Language:</i>	English, French, Spanish, German
<i>Dimensions:</i>	L x W x H: 650 x 100 x 30mm
<i>Weight:</i>	720g
<i>Included in the box:</i>	Reader, Quick Start guide, LiveTrack manager software, CD Manual Hand strap, Serial cable, 12v DC international Power Supply
<i>Certifications:</i>	CE, IC, FCC, C-Tick

## Some features of the Syscan LiveTrack® Reader:

- Lightweight, Robust, Ergonomic
- Read Alert via Vibration and Sound
- Compatible with SmartScale® 500, 700, 800 and other brands
- Long (650mm) reader snout for easier reading

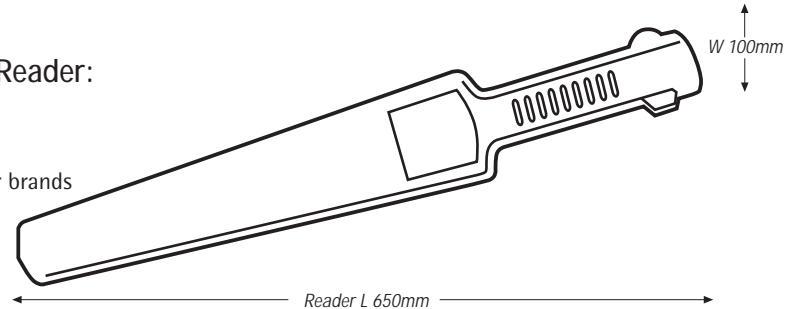
ORDER  
CODE

## PRICING

### SYSCAN ELECTRONIC HANDHELD READER

GRSWL	Syscan® Bluetooth Wand Reader, Long version ISO HDX/FDX ..... 805,00
GRSSO	Management Software for Syscan® SS1 + 2.....Included

Download full datasheets  
at [www.daltonid.com](http://www.daltonid.com)

# PanelReader



Animal Management

- ▶ Automatic Tuning every session
- Memory for 20,000 tags
- Easy to install yourself
- £ Included Software and accessories



Switchable options

> 1.2m Reading range

Wireless synchronisation and software diagnosis

HDX and FDX-B compatible

Controller/reader can be un-hooked for easy storage

Steel Reinforced mounting positions



QUESTIONS? FREEPHONE: 0800 838 882

# Technical Data

Frequency:	134.2 KHz
Transponder Types:	HDX compatible (ISO 11784/5) FDX-B compatible (ISO 11784/5)
Memory:	20,000 tags
Display:	2 x 10 OLED that displays over 30 messages
Reading range:	> 1.2m
Interfaces:	Bluetooth class 1 (100m) + serial
Power supply:	Li-ION Rechargeable providing 8 hours of continuous reading
Protection level:	IP 67
Temperature range:	-25°C to +85°C

## Features of the Gallagher "R" Panel Reader:

- Automatic Tuning every session
- 12 volt Adapter included
- Controller/Reader can be un-hooked from Panel for easy storage or attached to another panel
- Additional Antenna Panels can be purchased for multiple sites
- Wireless Synchronisation
- Tough one piece fully sealed Antenna Panel available in 600mm or 1300mm heights
- Full range of accessories + software
- Steel Reinforced mounting positions
- Switchable Options
- Plug + Play with Gallagher SmartScale®



Full range of accessories, installation material and Gallagher MyScale® Pro software included

## Additional Features of the "BR" Model:

- Battery providing 8 hours use
- Battery charge indicator + re-charge unit
- 20.000 Tag Memory
- Counter with Multiple Sessions
- Optional Bluetooth
- Water Proof / Air Tight to IP67 for harsh environments

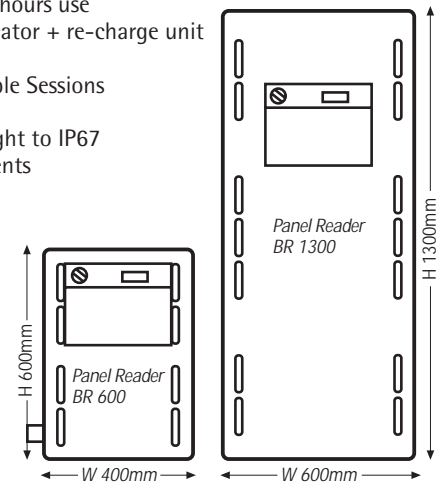
ORDER  
CODE

## PRICING

### GALLAGHER ELECTRONIC PANEL WALK-BY READERS

GFGBR	Gallagher® Reader Controller BR, ISO Auto tuning, int. battery.....1,950,00
GFP64	Panel Antenna 600 x 400mm.....499,00
GFP13	Panel Antenna 1300 x 800.....750,00
GFGSO	Diagnostic Configurator Software.....Included
GFGEX	Extension Kit/Bracket (Raise and reverses reader unit)....21,50
GFGDU	Bluetooth Dongle USB.....16,00
GFGDR	Bluetooth Dongle RS232.....17,00